



MARATHON
P O W E R

Sprint Series

**Line-Interactive
Uninterruptible Power Supply**

USER MANUAL

Introduction & Important Safety Instructions

Dear Customer,

Thank you for selecting a Marathon Power Uninterruptible Power Supply (UPS). You can rest assured that you have purchased a product consistent with our reputation for quality and reliability. It will provide you with years of protection against disruptive and costly power disturbances. As future needs arise, we hope you will consider other products of ours.

Sincerely,

Marathon Power Inc.

2538 E 54th Street
Huntington Park, CA 90255

Tel: 310-689-2328
Fax: 310-689-2329

Please take the time to read this manual!

It provides safety, installation and operating instructions that will allow you to derive the maximum performance and service life from your UPS.

Please store this manual in a safe place!

It contains important instructions for the safe use of the UPS and for obtaining factory service should you experience operational difficulties.

Please save or recycle the packaging materials!

They were designed to provide adequate protection from transport related damage. Since damage sustained during transit is not covered under warranty, we recommend saving the material in case the UPS needs to be returned for service or repair. Alternately, please recycle them.

IMPORTANT SAFETY INSTRUCTIONS

SAVE THESE INSTRUCTIONS

1. **WARNING (Save These Instructions):** This Manual Contains Important Instructions that should be followed during Installation and Maintenance of the UPS and Batteries.
2. The equipment can be operated by any individual. No previous experience is required.
3. **CAUTION (UPS with Internal Batteries):** Risk of electric shock - Hazardous live parts inside this unit are energized from the battery supply even when the input AC power is disconnected.
4. **CAUTION (No User Serviceable Parts):** Risk of electric shock, do not remove cover. No user serviceable parts inside. Refer servicing to qualified service personnel.
5. **CAUTION (Non-isolated Battery Supply):** Risk of electric shock, battery circuit is not isolated from AC input; hazardous voltage may exist between battery terminals and ground. Test before touching. Refer to top, rear and/or underside of the unit for cautionary markings.
6. **WARNING (Fuses):** To reduce the risk of fire, replace only with the same type and rating of fuse.
7. **WARNING:** Intended for installation in a controlled environment. The maximum ambient temperature is 77°F / 25°C.
8. **CAUTION:** When replacing batteries, replace with the same type and number of batteries: One 12V, sealed lead acid battery, rated at 9Ah (800VA - 2200VA) or 7.2Ah (425VA - 625VA).
9. **CAUTION:** Do not dispose of batteries in a fire, as they may explode.
10. **CAUTION:** Do not open or damage the battery, electrolyte may be released which is harmful to the skin and eyes.
11. **CAUTION:** A battery can present a risk of electric shock and high short circuit current. The following precautions should be taken when working with batteries:
 - a. Remove watches, rings and other jewelry or metal objects.
 - b. Use only tools with insulated handles.
 - c. Wear rubber gloves and boots.
 - d. Do not lay tools or metal parts on top of batteries.
 - e. Disconnect charging source prior to connecting or disconnecting battery terminals.
12. To reduce the risk of electric shock, disconnect the UPS from the AC input power supply before installing a communication interface cable. Reconnect the power cord only after communication interconnections have been made.
13. **CAUTION (High Leakage Current - Ground Connection Essential):** The total leakage current for the UPS and any connected equipment shall not exceed 3.5 mA.
14. **CAUTION:** Risk of electric shock. Heatsink is live. Disconnect unit before servicing.
15. **CAUTION (For All 120V Models Only):** To reduce risk of fire, connect only to a circuit provided with 20 amperes maximum branch circuit over-current protection in accordance with the National Electric Code, ANSI/NFPA 70.

Table of Contents

Section	Page
1. Overview	1
2. Safety	1
3. Functionality	2
4. Installation	4
5. Operation	5
6. Alarms	6
7. Software Options	7
8. Care & Maintenance	7
9. Computer Interface Port	8
10. Battery Replacement	8
11. Storage	10
12. Troubleshooting	10
13. Specifications	11
14. Product Warranties	13

1. Overview

The Sprint series is made up of a broad range of line-interactive models in both Tower and 19" Rack-Mount configurations. Line interactivity implies Automatic Voltage Regulation which uses buck / boost circuitry to correct for input voltage variations ranging from 75% to 125% of nominal, without the need to transfer to battery, while maintaining a constant output to the load.

They feature microprocessor control of battery charging and since this is a continuous function, there is no need to switch the UPS on in order for charging to be activated. To reduce the cost of ownership, the units turn off automatically ("Sleep Mode") if none of the connected equipment is operating. There is battery replacement indication and a cyclical self-test function that verifies both UPS operation and battery condition. They also feature a "cold-start" function that allows the user to power-up the load directly from the UPS without the availability of utility power.

In addition, the UPS provides single telephone line or modem surge suppression through the modular connectors on the rear panel, as well as on the AC output receptacles.

Using the UPS with the included software* and interconnecting cable, allows intelligent control of the system when linked to a host computer. (Some operating systems may require the use of other optional software).

Dry contacts, accessible via the standard RS-232, connector, allow for remote signalling of basic functions such as Power Normal, Backup Mode, and Low Battery states as well as Remote Shutdown.

* Software is presently available for PC operating systems only. Later versions may be available for Macintosh operating systems.

2. Safety

WARNINGS AND CAUTIONS!

Please be aware of, and observe the following:



- To reduce the risk of electric shock, disconnect the UPS from the main AC supply before installing a computer interface cable. Reconnect the power cord only after the signaling interconnections have been made.
- The internal energy source (the battery) cannot be de-energized by the user. The output may be energized when the unit is not connected to the AC supply.
- The correct way to de-energize the UPS properly in an emergency is to move the I/O switch to the OFF position and disconnect the power cord from the main supply.
- Even when the unit is disconnected, risk of electric shock from parts energized by the battery inside the unit still exists. To avoid this, the battery supply should be disconnected at the positive and negative terminals.
- The outlet sockets should be installed near the equipment and easily accessible.
- Do not dispose of batteries in a fire as they may explode. Please contact tech support for proper disposal instructions.
- Do not open or attempt to dismantle the battery, as electrolyte that is harmful to the skin and eyes may be released.
- A battery can present a risk of electric shock and high short circuit current. The following precautions should be taken when working with them:
 - Remove watches, rings and other jewelry or metal objects.
 - Use tools with insulated handles.
- To reduce risk of fire, replace only with same type and rating of fuse.
- To reduce the risk of fire or electric shock, install the UPS in a temperature and humidity controlled indoor area free of conductive contaminants.

3. Functionality – Front Views

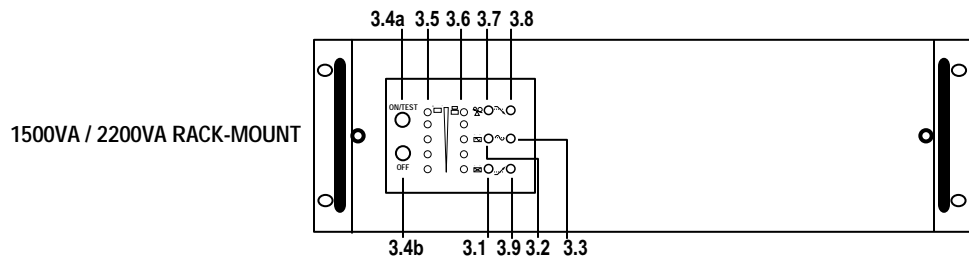
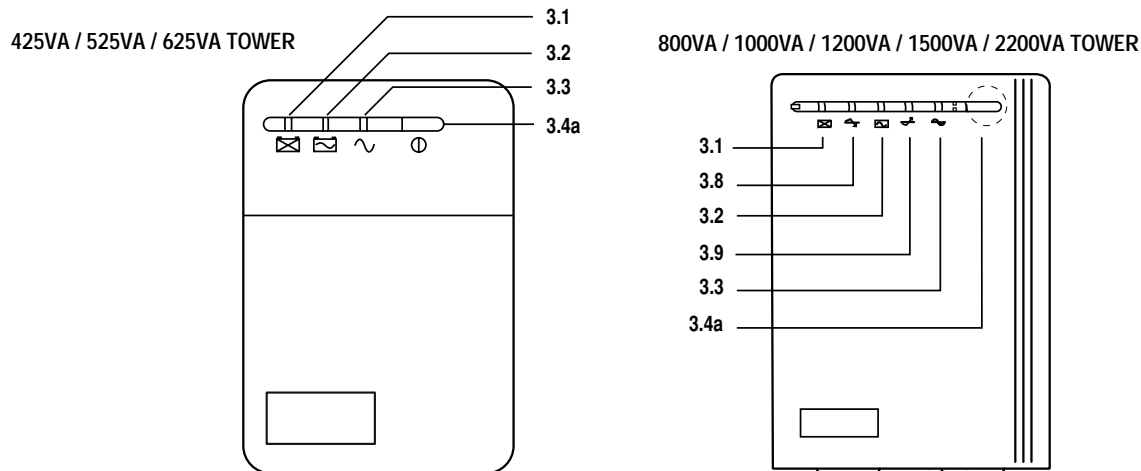

(not to scale)

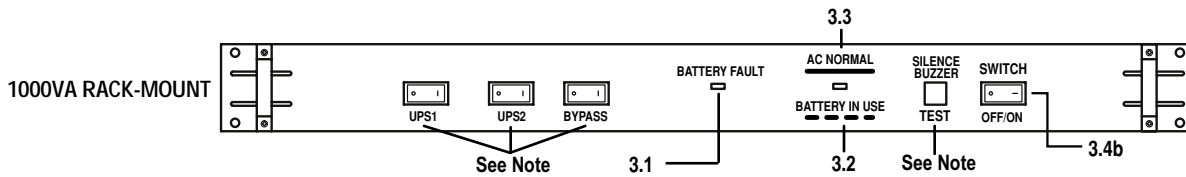

3.1 “REPLACE BATTERY / BATTERY FAULT” Indicator

This LED illuminates when the UPS’s battery is no longer useful and must be replaced. See section 10.

3.2 “BACKUP” Indicator

This LED illuminates when the UPS is supplying battery power to the loads.

3.3 “LINE NORMAL / AC LINE” Indicator

This LED will illuminate when the AC line input voltage is normal.

3.4a “ON / OFF / TEST / SILENCE” Button (All Tower Models)

Once connected, pressing this button for more than 2 seconds turns the UPS ON or OFF. Depressing it for less than 1 second activates the self-test function (while in normal power mode) or silences the alarm (while in back-up mode).

3.4b “OFF” Button / Switch (19" Rack-Mount models)

Turns the UPS OFF (and ON in the case of the 1000VA model).

3.5 BATTERY BAR GRAPH (19" Rack-Mount models - 1500VA / 2200VA)

Depressing it for less than 1 second silences the alarm (while in back-up mode).

3.6 LOAD BAR GRAPH (19" Rack-Mount models - 1500VA / 2200VA)

Allows connected equipment to be powered up or down independent of the UPS status.

3.7 OVERLOAD Indicator (19" Rack-Mount models - 1500VA / 2200VA)

Allows the UPS to be powered down & serviced without interrupting power to the connected equipment.

3.8 "BUCK" (AVR) Indicator

This LED illuminates when the UPS is correcting a voltage swell or over-voltage condition.

3.9 "BOOST" (AVR) Indicator

This LED illuminates when the UPS is correcting a voltage sag or undervoltage condition.

NOTE: 1000VA Rack-Mount model may feature additional controls such as independent load power & bypass switches

3. Functionality - Rear Views

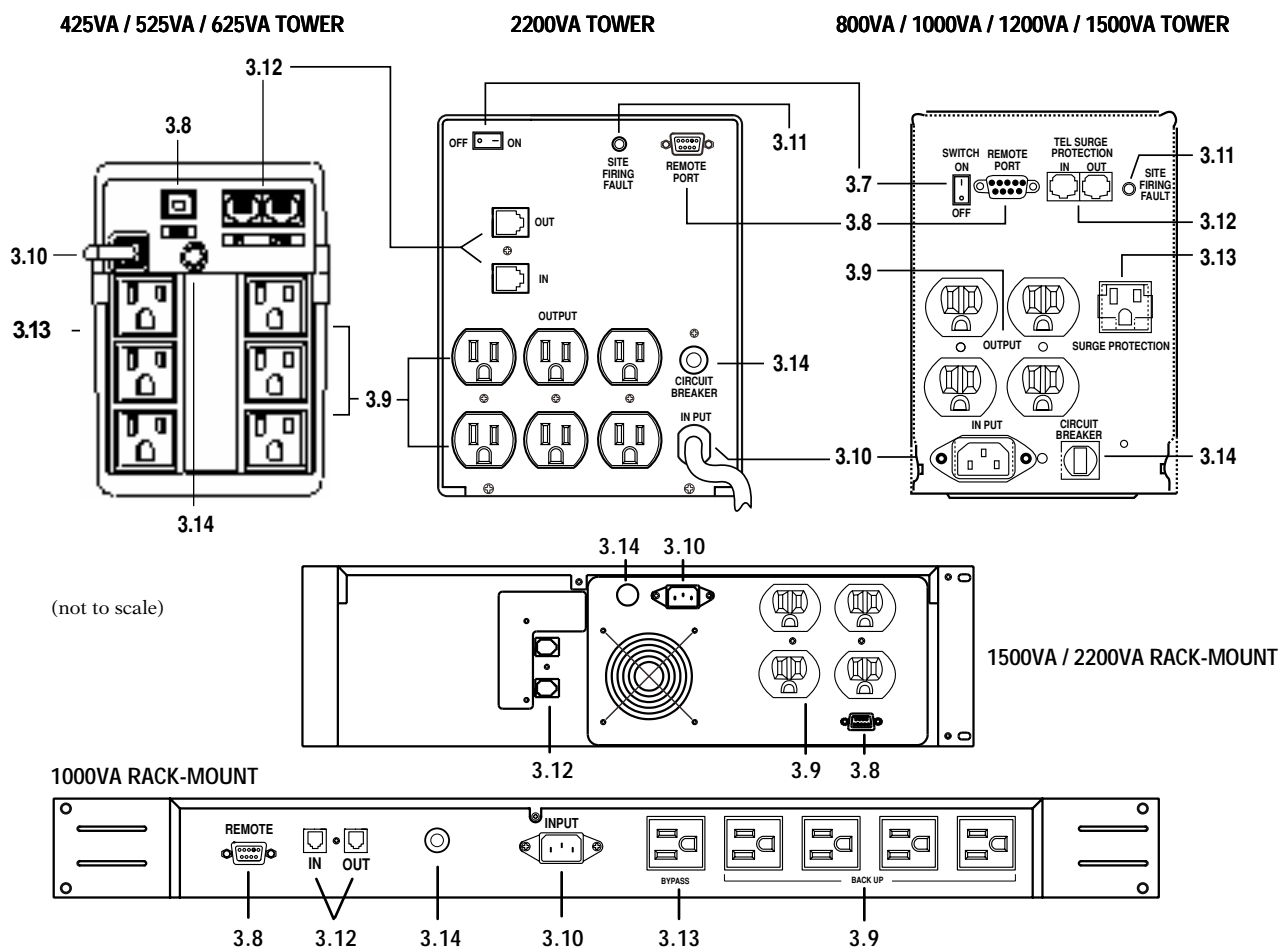

3.7 MAIN POWER SWITCH (800VA, 1000VA, 1200VA, 1500VA & 2200VA)

3.8 COMPUTER INTERFACE

Either an RS-232 (with solid state signaling) or USB port supports various operating systems.

3.9 AC OUTPUT POWER RECEPTACLES WITH BATTERY BACK-UP

3.10 AC INPUT POWER RECEPTACLE / CORD

3.11 SITE WIRING FAULT INDICATOR (RED LED) (Some models only)

This LED illuminates when the UPS is connected to an improperly wired AC power outlet.

3.12 TELEPHONE / MODEM SURGE PROTECTION Sockets

Surge protection for telephone and modem lines.

3.13 AC SURGE PROTECTION Socket (s) (Some models only)

Surge protection for an additional load. (This outlet is not backed-up).

3.14 INPUT CIRCUIT BREAKER / FUSE

A circuit breaker that trips when the connected loads exceed the protected receptacle's capacity or when a short circuit occurs. Press the plunger in the center of the breaker to reset. All other models have a fuse that blows under the same conditions.

 **CAUTION:** Replace only with same fuse type and rating.

4. Installation

4.1 Inspection

Inspect the UPS upon receipt for any visible damage. The packaging is recyclable; save it for reuse or dispose of it properly.

 **NOTE:** If the power consumption of the load is listed in units other than VA (e.g., Watts), use the following calculations for conversion:

$$\text{_____ Watts(W)} \times 1.67 = \text{_____ VA} \quad \text{OR} \quad 120\text{V} \times \text{_____ Amps(A)} = \text{_____ VA}$$

4.2 Placement

Install the UPS in a protected area with adequate airflow and free of excessive dust.

 **CAUTION:** Do NOT operate the UPS where the temperature and humidity is outside the specified limits.

4.3 Telephone / Modem Connection

Connect a single line telephone or modem line to the telephone/modem surge protection sockets in the rear of the UPS. The RJ-45/RJ-11 modular sockets accept standard single line telephone connectors. This connection requires an additional length of telephone cable (supplied).

 **NOTE:** The telephone/modem line connection is optional and not necessary for the UPS to function correctly.

 **CAUTION:** The telephone line current limiting feature may be rendered inoperable if improperly installed. Make sure that the telephone line from the wall is plugged into the connector labeled "IN" and the device to be protected (telephone, modem, etc.) is plugged into the connector labeled "OUT".

 **CAUTION:** This surge protection device is for indoor use only. Never install telephone wiring during a lightning storm.

4.4 Power Source Connection

Connect the AC power cord to a properly wired and grounded outlet to energize the UPS.

4.5 Battery Charging

The UPS charges its battery whenever it is connected to utility power. For optimum results, charge the battery for at least 6 hours prior to initial use.

4.6 Load Connection

Plug the load(s) into the output connectors in the rear of the UPS. To use the UPS as a master ON/OFF switch, make sure all of the loads are switched ON.

 **CAUTION:** Do NOT connect a laser printer or plotter to the UPS with other computer equipment. A laser printer or plotter periodically draws significantly more power when in use, and may overload the UPS.

4.7 Site Wiring Fault Indicator Inspection (Applicable models only)

After connecting the loads and the UPS, check the site wiring fault indicator on the rear panel. See section 3 for location of the indicator on the rear panel. It will illuminate if the UPS is connected to an improperly wired AC power outlet. Wiring faults detected include: no ground, line-neutral polarity reversal, and overloaded neutral circuit.

4.8 Computer Interface Connection (optional)

A software and interface kit is included with each UPS. If used, ensure that all associated/connected equipment is OFF and connect one end of the interface cable to the computer interface port (USB or RS-232) on the back panel of the UPS and the other end to an unused port on the computer. Use only kits and/or cables supplied or approved by manufacturer. See section 7 for additional info.



NOTE: The computer interface connection is optional and not necessary for the UPS to function correctly.

4.9 Rack Mount Models

Depending on installation, 19" rack-mount applications may require the use of guide rails and/or brackets to support the weight of the UPS. Please contact the manufacturer of your rack or enclosure to purchase suitable mounting/installation hardware.

A Note on RFI (Radio Frequency Interference)

There is no guarantee that interference to a radio or TV receiver will not occur in a particular installation. If the UPS causes interference to radio or television reception, which can be determined by turning the UPS OFF and ON, the user is encouraged to try to rectify the problem by trying one or more of following:

- Connect the equipment to an outlet on a circuit different from that to which the receiver is connected.
- Increase the separation between the equipment and the receiver.
- Re-orient the receiving antenna.

5. Operation

5.1 Turn-ON



1000VA Rack-Mount ONLY Note: To turn the unit on, toggle ON/OFF switch to ON position.

With the UPS plugged in, press the ON/TEST button more than 2 seconds to energize the UPS. It will perform a self-test each time it is switched ON.



NOTE: When switched OFF, the UPS will maintain and continue to charge the battery and also respond to commands received through the computer interface port.

5.2 Turn-OFF



1000VA Rack-Mount ONLY Note: To turn the unit off, toggle ON/OFF switch to OFF position.

Press and hold the OFF button until the "LINE NORMAL" or "BACKUP" LED turns OFF.

5.3 Self-Test

Use the self-test to verify both the operation of the UPS and the condition of the battery. To perform the self-test, press the ON/TEST button more for more than 1 second, but less than 2 seconds, under normal power conditions. During the self-test, the UPS will operate in back-up mode.



NOTE: During the self-test, the load(s) use battery energy. The "ON BATTERY" LED will illuminate, (or flash) indicating the UPS is supplying battery power.

If the UPS passes the self-test, it will return to normal on-line operation. The "ON BATTERY" LED will turn off and the "ON LINE" LED will illuminate.

If the UPS fails the self-test, it immediately returns to on-line operation and the “REPLACE BATTERY” LED will illuminate. The loads are not affected. Recharge the battery overnight and perform the self-test again. If the “REPLACE BATTERY” LED is still illuminated, call tech support for battery replacement instructions.

5.4 Audible Alarm Silencing

To silence the audible alarm, press the ON/TEST button for less than one second while the UPS is in back-up mode. On the 1000VA Rack-Mount model, press the BUZZER button



NOTE: This function will not work when the UPS is under “Low Battery” or “Overload” conditions.



NOTE: In back-up mode, the UPS will automatically turn OFF if none of the connected loads are in operation or if they consume less than 15 watts (“Sleep Mode”). This feature can be disabled if necessary.

5.5 Cold Start

When the UPS is OFF and there is no utility power available or present, the cold start feature can be used to apply power to the loads from the UPS using the battery as the power source. Press the ON/TEST button until the UPS beeps.



1000VA Rack-Mount ONLY Note: With UPS unit OFF and no utility power, toggle ON/OFF switch to ON position

5.6 Shutdown Mode

In this mode, the UPS ceases supplying power to the load while waiting for the return of utility power. If utility power is not restored, an external device such as a server connected to the computer via the interface can command the UPS to shutdown. This is typically done to preserve battery capacity after the proper shutdown of protected loads.

6. Alarms

6.1 “BACKUP” (slow alarm)

When in back-up mode, an LED illuminates (or flashes) and the UPS sounds an audible alarm. The alarm stops when the UPS returns to LINE NORMAL operation. The alarm can be silenced by briefly pressing the “ON/TEST” button when the on-battery alarm sounds.

6.2 “LOW BATTERY” (rapid alarm)

In back-up mode, when the battery level runs low, the UPS beeps rapidly until either the UPS shuts down due to battery depletion or it returns to LINE NORMAL operation.

6.3 “OVERLOAD” (continuous alarm)

When the UPS is overloaded (i.e., the connected load(s) exceed the maximum rated capacity) the UPS emits a continuous tone to warn of an overload condition. Disconnect non-critical loads from the UPS to eliminate the overload.

6.4 “REPLACE BATTERY” (continuous alarm) (Some models only)

The UPS emits a continuous tone and the “REPLACE BATTERY/BATTERY FAULT” LED illuminates if the battery fails the self-test. See section 10 for instruction on user battery replacement or contact tech support for assistance.

7. Software Options

7.1 Power Monitoring Software



NOTE: Please refer to the back of the software CD holder for installation instructions. For operational instructions, install the software, launch the program then click HELP in the upper left corner of the software application screen.

The software is applied via the standard RS-232 or USB interface to perform monitoring functions, as well as to implement an orderly shutdown of a computer in the event of a continuous power failure. In addition, the software displays diagnostic features, such as: input and output voltage, frequency, battery and load level visually on your computer monitor.

The software is usable with DOS, Windows 95 or higher, Windows NT V3.5 or later, and others. Contact tech support for more information on alternative computer OS compatible software.

7.2 Interface Kits

Included interface kit provides UPS monitoring. Each kit includes a special cable to convert status signals from the UPS into signals which individual operating systems recognize. One end of the cable is connected to the remote port on the UPS and the other end to an used COM or USB port on the computer.



NOTE: Use only a factory supplied or authorized monitoring cable.

8. Care & Maintenance

1. Keep the unit clean. Wipe with a soft, damp cloth.
2. Check for loose and/or bad connections regularly.
3. Avoid direct sunlight, rain, and high humidity.
4. Keep away from fire and extremely hot locations.
5. Do not stack anything on top of the unit.
6. The unit should not be exposed to corrosive environments.
7. Normal operating temperature is 32 to 104°F (0-40°C).

9. Computer Interface Port

The ports are configured as follows:

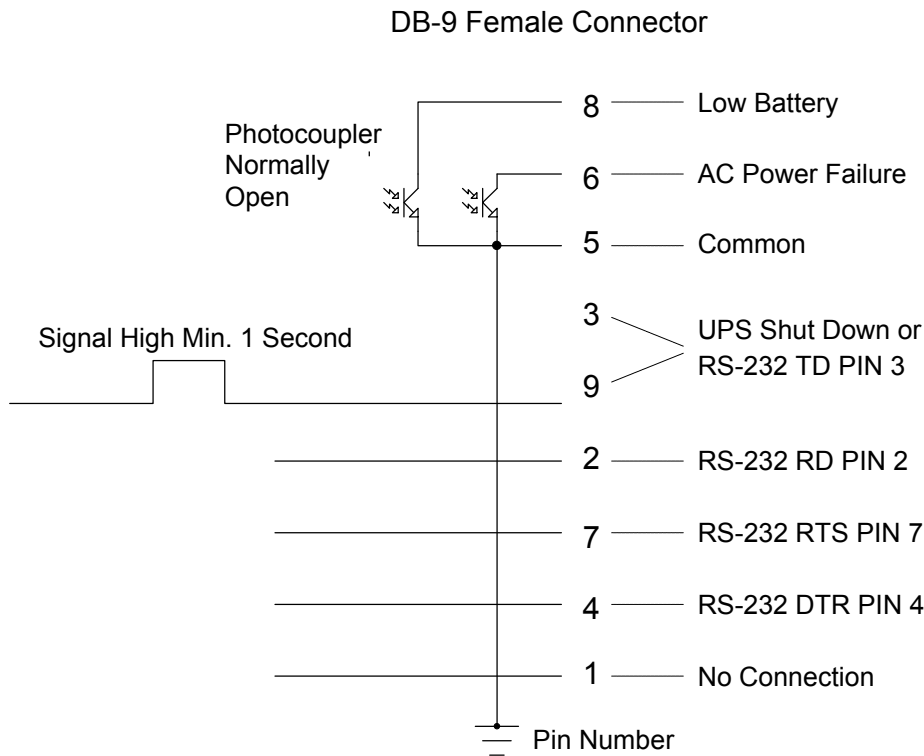

10. Battery Replacement



NOTE: Under normal operation, the battery's life span will be 3-5 years before requiring replacement.



CAUTIONS:

- Do NOT dispose of the battery in a fire.
- Do NOT attempt to open or dismantle the battery.
- Remove watches, rings, and other jewelry.
- Use tools with insulated handles.

Marathon Power strongly recommends that the user contact tech support for assistance with battery replacement.

To change the battery in the **425VA, 525VA & 625VA Tower** units:

1. Unplug the UPS unit from the AC power source and disconnect all connected equipment.
2. Disconnect the AC power cord from the UPS.
3. Turn the unit upside down and using a Phillips screwdriver, remove the four (4) screws holding the top cover of the unit to the bottom section. Store the screws in a safe place.
4. Holding the top together firmly with the bottom, turn the unit right side up.
5. Carefully lift the top cover off and place it to one side. The interconnecting wires and electronics will be exposed. Be careful not to touch any inner components when changing the battery.
6. Remove the two (2) connecting wires from the battery.
7. The battery can now be removed from the unit.

8. Place the new battery in the same position / direction as before and reconnect the wires. Connect the RED wire to Positive (+) and the BLACK wire to Negative (-).
9. Follow the reverse of steps above to re-assemble the UPS.
10. Follow user manual instructions in section 4 to correctly reconnect the UPS loads.

To change the battery(ies) in the **19" Rack-Mount** units:

1. Unplug the UPS unit from the AC power source and disconnect all connected equipment.
2. Remove rack mount brackets..
3. Disconnect the AC power cord from the UPS.
4. Turn the unit upside down and using a Phillips screwdriver, remove screws underneath and at the back of the unit.
Store the screws in a safe place.
5. Holding the top together firmly with the bottom, turn the unit right side up.
6. Carefully remove the top cover and place it to one side. The interconnecting wires and electronics will be exposed.
Be careful not to touch any inner components when changing the battery.
7. Remove the securing bracket and two (2) primary connecting wires from the battery(s).
Make sure to take note of the wire location to ensure correct routing during re-assembly.
8. The battery(s) can now be removed from the unit.
9. Place the new battery in the same position / direction as before and reconnect the wires. Connect the RED wire to Positive (+) and the BLACK wire to Negative (-).
10. Follow the reverse of steps above to re-assemble the UPS.
11. Follow user manual instructions in section 4 to correctly reconnect the UPS loads.

To change the battery(ies) in the **800VA, 1000VA, 1200VA, 1500VA & 2200VA Tower** units:

1. Unplug the UPS unit from the AC power source and disconnect all connected equipment.
2. Disconnect the AC power cord from the UPS.
3. Place one hand on top of the unit to secure it. With the appropriate fingers on the other hand placed in the recesses on either side, gently pull the front panel forward until it disengages. Do NOT pull it too far forward because there is a wire harness connected to it from the inside of the unit.
4. The interconnecting wires and electronics will be exposed. Be careful not to touch any inner components when changing the battery.
5. Disconnect the wire harness and place the panel to one side while the battery is removed. Alternately, leave it connected and rotate it so that it rests on top of the unit and out of the way.
6. Remove the securing screw and then the battery cover plate.
7. The battery can now be removed from the unit. Slide the battery out, disconnect and discard accordingly.
8. Place the new battery in the same position / direction as before and reconnect the wires. Connect the RED wire to Positive (+) and the BLACK wire to Negative (-).
9. Follow the reverse of steps above to re-assemble the UPS.
10. Follow user manual instructions in section 4 to correctly reconnect the UPS loads.



NOTE: For proper battery disposal & recycling information, please call **800-RE-USE-Pb.**
(800-738-7372)

11. Storage

11.1 Storage Conditions

Store the UPS covered, upright and in a cool, dry location, with its battery fully charged. Before storing, charge the UPS for at least 4 hours. Remove any accessories from the unit slot and disconnect any cables connected to the computer interface port to avoid draining the battery.

11.2 Extended Storage

During extended storage in environments where the ambient temperature is +5 to +86°F (-15 to +30°C), charge the UPS's battery every 6 months. During extended storage in environments where the ambient temperature is +86 to +113°F (+30 to +45°C), charge the UPS's battery every 3 months.

12. Troubleshooting

<i>Problem</i>	<i>Possible Cause</i>	<i>Corrective Action</i>
Unit will not turn ON and/or the relevant LEDs do not illuminate	ON/OFF/TEST/SILENCE button not pushed or not pushed long enough	Press the ON/OFF/TEST/SILENCE button for more than 2 seconds
	Battery voltage is too low	Recharge the unit for at least 4 hours
	Circuit board failure	Call tech support for service
	Connected load is less than 20W in back-up mode	None – this is a normal condition
Unit always in back-up mode	Loose power cord	Re-insert the power cord
	Blown fuse / Tripped Circuit Breaker	Replace the AC fuse / Reset Breaker
	Line voltage is too high, too low or not present	None – this is a normal condition The unit is functioning as it should
Back-up time too short	Battery not fully charged	Recharge the unit for at least 4 hours
	Circuit board failure	Call tech support for service
Audible alarm sounds continuously	Overload condition	Disconnect non-critical loads from the unit
	Faulty battery	Replace battery
RED LED illuminated	Battery failure	Replace the battery – call tech support for service

13. Specifications

Tower Models

GENERAL

Rated Capacity: 425VA, 525 VA, 625 VA, 800VA, 1000 VA, 1200 VA, 1500VA, 2200VA
Technology: Line-interactive topology with simulated sinewave output on battery

INPUT

Phase: Single phase plus ground
Input Voltages: 110V, 115V, 120V or 220V, 230V, 240V
Input Voltage Range: $\pm 25\%$
Frequency: 50 / 60 Hz auto sensing
AC Frequency Range: 45 - 65 Hz
Input Current (120V): 425-3.5A, 525-4.4A, 625-5.2A, 800-6.7A, 1000-8.3A, 1200-10A, 1500-12.5A, 2200-18.3A
Input Current (230V): 425-1.8A, 525-2.3A, 625-2.7A, 800-3.5A, 1000-4.3A, 1200-5.2A, 1500-6.5A, 2200-9.6A
Input Protection: Fuse or circuit breaker for overload and short circuit (model dependent)
DC Bus Voltage: 425VA ~ 625VA - 12V, 800VA ~ 1500VA - 24V, 2200VA - 48V

OUTPUT

Output Voltage: 110V, 115V, 120V or 220V, 230V, 240V
Voltage Regulation: $\pm 5\%$ (425VA - 2200VA)
Power Factor: 0.6
Frequency Regulation: $\pm 1\%$ (while on battery)
Automatic Voltage Regulation: Increases or decreases output voltage by 15% if the input voltage decreases or increases by between 9% and 25%
Transfer Time: Between 2 and 4 milliseconds including detection time
Efficiency (Standby Mode): Greater than 95%
Overload Capacity: 110% for 60 seconds, 130% for 3 seconds

19" Rack-Mount Models

GENERAL

Rated power: 1000 VA, 1500 VA, 2200 VA
Technology: Line-interactive topology with simulated sinewave output on battery

INPUT

Phase: Single phase plus ground
Input Voltages: 110V, 115V, 120V or 220V, 230V, 240V
Input Voltage Range: $\pm 25\%$
Frequency: 50 / 60 Hz auto-sensing
AC Frequency Range: 45 - 65 Hz
Input Current (120V): 1000VA - 8.3A, 1500VA - 12.5A, 2200VA - 18.3A
Input Current (230V): 1000VA - 4.3A, 1500VA - 6.5A, 2200VA - 9.6A
Input Protection: Fuse or circuit breaker for overload and short circuit (model dependent)
DC Bus Voltage: 1000VA - 18V, 1500VA - 24V, 2200VA - 48V

OUTPUT

Output Voltage: 110V, 115V, 120V or 220V, 230V, 240V
Voltage Regulation: $\pm 5\%$ (1000VA - 2200VA)
Power Factor: 0.6
Frequency Regulation: $\pm 1\%$ (while on battery)
Automatic Voltage Regulation: Increases or decreases output voltage by 15% if the input voltage decreases or increases by between 9% and 25%
Transfer Time: Between 4 and 8 milliseconds including detection time
Efficiency (Standby Mode): Greater than 95%
Overload Capacity: 110% for 60 seconds, 130% for 3 seconds

13. Specifications (Cont'd)

All Models

ALARMS AND INDICATORS

Battery Backup:	Slow beeping tone (approx. 0.25Hz)
Battery Low:	Rapid beeping tone (approx. 1.00Hz)
Overload:	Continuous tone
Front Panel Display:	LED's
LED Display Parameters: (425VA ~ 625VA models)	On Line (AC normal), On Battery (AC failure), Battery Fault
LED Display Parameters: (800VA ~ 2200VA models)	On Line (AC normal), On Battery (AC failure), Battery Fault, AVR Boost, AVR Buck
Communication (std): (optional):	RS-232 communication port and solid state signaling or USB SNMP/WEB card or module for monitoring and control on a network or the internet

STANDARDS

Safety:	EN50091-1-1
Emissions:	EN50091-2 class B
Immunity:	EN50091-2
Conformity:	UL 1778, cUL 107.1, 107.2, (120V models), CE (230V Models)
Transient Immunity (120V):	Per IEEE 62.41 (formerly IEEE 587)
Transient Immunity (230V):	Per IEEE C 61000-4-5 level 3

ENVIRONMENTAL

Ambient temperature range:	+32 °F to +86°F (+0 °C to +30 °C)
Optimum temperature range:	+59 °F to +77°F (+15 °C to +25 °C)
Storage temperature:	+5 °F to +122°F (-15 °C to +50 °C)
Cooling:	Natural convection (425VA ~ 800VA), Forced air (1000VA ~ 2200VA)
Humidity:	0-95%, non-condensing
Elevation:	10,000 feet max (operation), 45,000 feet (storage)
Audible noise:	< 40 db normal and battery mode (All models)

MODEL & PART NUMBER DESIGNATION

120V Tower Models:	STWC-0425-01, STWC-0525-01, STWC-0625-01, STWS-0800-01,
120V Tower Models:	STWS-1000-01, STWS-1200-01, STWS-1500-01, STWS-2200-01
230V Tower Models:	STWC-0425-02, STWC-0525-02, STWC-0625-02, STWS-0800-02,
230V Tower Models:	STWS-1000-02, STWS-1200-02, STWS-1500-02, STWS-2200-02
120V Rack-Mount Models:	SRMS-1000-01, SRMS-1500-01, SRMS-2200-01
230V Rack-Mount Models:	SRMS-1000-02, SRMS-1500-02, SRMS-2200-02

13. Specifications (Cont'd)

Tower Models

Capacity	425VA / 255 W	525VA / 315 W	625VA / 375 W	800VA / 480 W
Input Connection	Fixed power cord			Removable IEC cord
Output Connection	6 x NEMA 5-15R (3 backed up and 3 surge only)			5 x NEMA 5-15R
Battery Type & Rating	Sealed, lead-acid 7.2Ah/12V	Sealed, lead-acid 7.2Ah/12V	Sealed, lead-acid 7.2Ah/12V	Sealed, lead-acid 7.2Ah/12V
Battery Quantity	1	1	1	2
Backup time (full load)	4 min	4 min	4 min	7 min
Recharge time	<4 hours to 90%			
Dimensions ins/mm W x D x H	3.8 x 12.6 x 5.3 97 x 320 x 135			5.1 x 15 x 7.9 130 x 382 x 201
Weight lbs/kg (net)	12.8 / 5.8	13.7 / 6.2	14.3 / 6.5	28.6 / 13

Tower Models

Capacity	1000VA / 600W	1200VA / 720 W	1500VA / 900 W	2200VA / 1320 W
Input Connection	Removable IEC power cord			Fixed power cord
Output Connection	5 x NEMA 5-15R			6 x NEMA 5-15R
Battery Type & Rating	Sealed, lead-acid 7.2Ah/12V	Sealed, lead-acid 7.2Ah/12V	Sealed, lead-acid 7.2Ah/12V	Sealed, lead-acid 7.2Ah/12V
Battery Quantity	2	2	2	4
Backup time (full load)	6 min	5 min	4 min	6 min
Recharge time	<6 hours to 90%			
Dimensions ins/mm W x D x H	5.1 x 15 x 7.9 130 x 382 x 201			6.7 x 17.6 x 8.4 170 x 448 x 214
Weight lbs/kg (net)	33 / 15	33.4 / 15.2	34.3 / 15.6	66 / 30

19" Rack-mount Models

Capacity	600VA / 360W	1000VA / 600 W	1500VA / 900 W	2200VA / 1320 W
Input Connection	Removable IEC power cord			Fixed power cord
Output Connection	5 x NEMA 5-15R		6 x NEMA 5-15R	
Battery Type & Rating	Sealed, lead-acid 7.0Ah/6V	Sealed, lead-acid 8.0Ah/6V	Sealed, lead-acid 8.5Ah/12V	Sealed, lead-acid 7.2Ah/12V
Battery Quantity	2	2	2	4
Backup time (full load)	4 min	5 min	5 min	6 min
Recharge time	<8 hours to 90%			
Dimensions ins/mm W x D x H	19 x 14.3 x 1.73 483 x 362 x 44		19 x 14 x 3.3 483 x 357 x 84	19 x 13.8 x 5.1 483 x 351 x 130
Weight lbs/kg (net)	20.5 / 9.4	25.3 / 11.5	35.9 / 16.3	62.6 / 28.4

14. Warranty

14.1 Limited Three-Year Warranty and Exclusions

NOTE: For this warranty to be valid, completed registration information must be received within 30 days of original purchase.

Marathon Power warrants to the original purchaser, who must have properly registered the product within 30 days of purchase, and not for the benefit of anyone else that this product at the time of its sale by Marathon Power is free of defects in materials and workmanship for three (3) years (batteries for 2 years within the USA, Canada and Mexico, otherwise 1 year) from the original purchase date. Marathon Power will correct such defects by repair or replacement, at its option, if within such three year period the product is returned prepaid and all warranty claim instructions are followed. This warranty excludes labor for removal or reinstallation of this product. This warranty is void if this product is installed improperly or in an improper environment, overloaded, misused, opened, abused, or altered in any manner, or is not used under normal operating conditions or not in accordance with all labels or instructions. There are no other or implied warranties of any kind, including merchantability and fitness for a particular purpose, but if any implied warranty is required by the applicable jurisdiction, the duration of any such implied warranty, including merchantability and fitness for a particular purpose, is limited to three years. Marathon Power is not liable for incidental, indirect, special or consequential damages, including damage to, or loss of use of, any equipment, lost sales or profits or delay or failure to perform this warranty obligation.

14.2 Limitations & Claims

This warranty does not cover any Marathon Power UPS or any properly connected electronic equipment which has been improperly installed, overloaded, abused or altered in any manner, or is not used under normal operating conditions, or in accordance with any labels or instructions, and does not cover any damage to properly connected electronic equipment resulting from a cause other than a "surge".

Damage caused by failure to provide a suitable installation environment for the product (including, but not limited to, lack of a good ground) will not be covered by this warranty. This warranty does not apply to damage caused by direct lightning strikes, or damage caused by electrical disturbances that exceed published product specifications. These products are intended to limit the maximum amplitude of transient voltage surges on power lines to specified values. They are not intended to function as surge arrestors. The UPS is intended to be installed on the load side of the service entrance and has been tested to verify that transient voltage surges are limited when subject to non-repetitive transient voltage surge events. This warranty excludes any incidental, indirect, special or consequential damages, including without limitation, labor for removal or reinstallation of the Marathon Power UPS or any connected electronic equipment, data loss or alteration loss of equipment use, lost sales or profits and any such damages for delay or failure to perform this warranty obligation. This warranty is in lieu of and excludes all implied warranties of merchantability or fitness for use. In addition, the warranty does not cover restoration of lost data and reinstallation of software. Some states may not allow the exclusion or limitation of incidental or consequential damages or other remedies, so the above exclusions or limitations may not apply to you.

Take the following steps to file a warranty claim: Contact us at Marathon Power, Inc., Attn: Returns, 2538 E. 54th Street, Huntington Park, California 90255 or call (310) 689-2328 within 30 days of the occurrence. Be prepared to provide detailed information about the event, any damage, the UPS model number, purchase date and location. You will then be provided with a Return Authorization Number (RAN), and be instructed to forward your proof of purchase (receipt), an explanation of the event and your UPS. If Marathon Power determines that the damage was due to a "surge", we may request that all connected equipment be submitted for evaluation. Marathon Power is not responsible for shipping costs. In the event that the equipment has been damaged by a "surge" Marathon Power will reimburse you for repair or replacement at fair market value (on a pro rata basis) as indicated by the respective amounts above. The warranty coverage is above and beyond, only to the extent needed, of that provided by any other source, including but not limited to any connected equipment coverage, any manufacturer's warranty or insurance policy. To receive payment for repair to damage due to a "surge," the original purchaser should (upon prior approval from Marathon Power) have such equipment repaired by an authorized service center of such equipment's manufacturer. The original purchaser will submit a repair bill along with a statement from the repair facility documenting the nature of the damage and how it was sustained to said equipment.

Copyright Marathon Power, Inc. 2007
www.marathon-power.com